

creative since 1965
the modular icon by
Fritz Haller & Paul Schärer

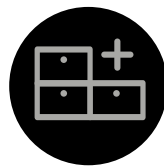

come home



Online Configurator
Design your individual
piece of USM online!



Quick Ship Shop
Order predesigned
pieces online for shipping
within 2 – 3 weeks
in the continental US!



Customized Service
Visit a USM Showroom or
one of our 400 international
sales partners worldwide for
individual support. Find your
closest USM professional
online.

www.usm.com



Price list
Scan the QR code
to view the price list.

- 4 Living room
- 14 Dining
- 20 Entertainment
- 28 Bedroom
- 34 Kids
- 38 Shelving
- 48 Storage
- 58 Home office

The USM world

- 68 USM and sustainability
- 70 Product information
- 80 Colors & surfaces

Home is our personal retreat,
the private space where we
share special time with family and
friends.

It is a reflection of our lifestyle,
our attitudes and the things
that mean the most to us. As our
lives and tastes change, our
home evolves with us – always
in sync with our current needs.

USM Modular Furniture is
designed to accompany us
through different phases of life.
It adjusts to new demands,
ready to take up different func-
tions in our home.

USM Haller is the epitome of timeless design: almost 60 years ago, Fritz Haller and Paul Schärer created a completely new aesthetic – a furniture system inspired by architecture.

Two visionaries, one idea

After completing his engineer studies, Paul Schärer Jr. joined the family business in 1961. The engineer had big ideas: he wanted to build a modern, industrial factory. He partnered with Fritz Haller, a respected architect of Solothurn school.

Born from architecture

Haller developed a flexible construction system with various steel modules. This inspired Paul Schärer Jr., who had a bigger vision: interior design that complements architecture. Together, they developed a modular piece of furniture that was predestined for further development.

Furniture with a system

The centrepiece of the system is a chrome-plated ball with six threaded holes. It connects the chrome-plated steel tubes in any combination. Finally, add sheet steel panels, which are powder-coated in various colours. Everything was intended for the company's own offices.

From prototype to USM Haller

When photos of the forward-thinking furniture system with its innovative aesthetics appeared in architecture journals, it was hailed an international sensation. A commission came from the Rothschild bank in Paris consisting of 600 workstations – the company's first major project. Series production began in 1969.

Less is more

With endless possibilities, the USM Haller system can be configured at will and adjusted to changing requirements, in all directions. Its strikingly fascinating minimalism is eye-catching and inspiring for everyone who values design, quality and functionality.

Modern art

An icon of modern design, USM Haller has been on display at the MoMA in New York since 2001 and recognised as a 'work of applied art' since 1988. USM Haller continues to evolve, while remaining true to itself by retaining original characteristics and invites users to challenge their own creativity.

From Münsingen out into the world

Alexander Schärer has headed up this fourth-generation family business since 2000. Production is still carried out at the headquarters in Münsingen. USM employs 450 people and currently has subsidiaries in the USA, France, Germany, UK, Japan and China. USM products are distributed by dealers in over 40 countries. Sustainability has always been a top priority. In 2008, USM was awarded Greenguard environmental certification and received the Cradle-to-Cradle® environmental label in 2018. The vision is to become a fully circular company by 2030. → S. 68

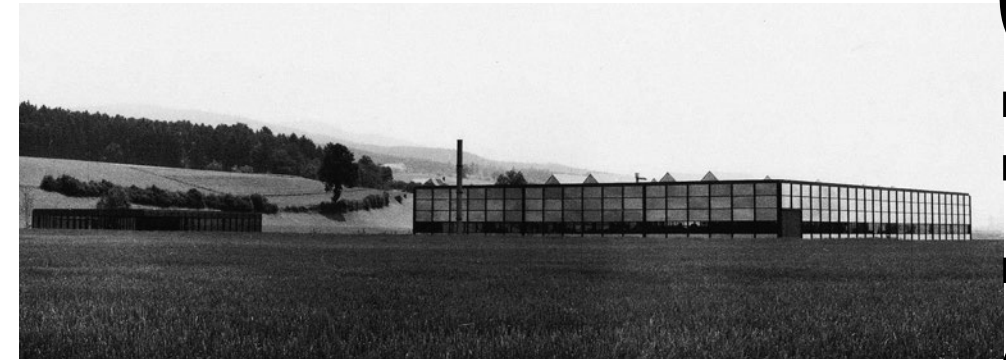

- 1 New factory (1963) and office pavilion (1965) in Münsingen, designed by Fritz Haller.
- 2 In 1965, USM Haller was developed to furnish personal use workspaces within visionary architecture.
- 3 Schärer family home (1969), designed by Fritz Haller, furnished with USM Haller.
- 4 The key to space. Balls, tubes, panels: what began 60 years ago continues to inspire today.

the modular icon by
Fritz Haller & Paul Schärer,
Switzerland

f. haller paul schärer

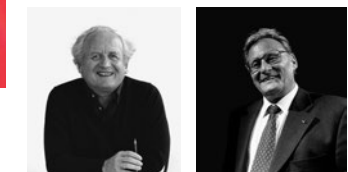

Living room

It is simply about living your ideas, your style.

Make your home personal. Clear lines, versatile modularity: USM Haller lets you decide. Unobtrusive but essential, it adapts to your lifestyle, your changing needs, your personal taste.

- 1 Sideboard
90"W/23"D/18"H
with one extension door
and castors



Living room



↙
2 Credenza
 90"W/15"D/29"H
 with three drop-down doors

→
3 Media unit with integrated USM Haller E lighting*
 60"W/15"D/17"H
 with two drop-down doors
 *with a dimmable cold or warm white light



4 Credenza 
 60"W/15"D/29"H
 with four drop-down doors



5 Credenza
 90"W/15"D/29"H
 with two drop-down doors
 and one drawer



6 Credenza
 150"W/15"D/29"H
 with three drop-down doors
 and three extension doors

Living room



7 Glass showcase with integrated USM Haller E lighting*
30"W/21"D/43"H with three glass doors
*with a dimmable cold or warm white light

8 Glass showcase 120"W/15"D/29"H with eight doors



9 Glass credenza 60"W/15"D/29"H with four glass doors



10 USM Haller side table, square 30"W/30"D/15"H Brown oiled oak veneer



11 Sideboard 40"W/41"D/21"H



12 Side table 20"W/15"D/16"H with one fixed shelf

Living room



Create the color combination of your dreams with our configurator.
www.usm.com

↙
13 Storage unit
90"W/60"D/29"H
with six drop-down doors
and one drawer

↓
14 Storage unit
143"W/15"D/84"H
with one drop-down door,
one flip-up door, three extension
doors with box insert and
a world of plants



Living room

↓
15 Side table
28"W/28"D/15"H

↓
16 Shelving
145"W/15"D/98"H
with nine drop-down doors

↓
17 Side table
20"W/21"D/17"H



Dining

Creating spaces
for family and friends
is priceless.

18 USM Haller table
79"W/39"D/29"H
transparent glass

19 Showcase with integrated
USM Haller E lighting*
99"W/15"D/73"H
with four extensions doors
and eight glass doors

* with a dimmable cold or
warm white light



Dining



20 Shelving
84"W/15"D/52"H
with three drop-down doors,
three extension doors with box
inserts, two glass doors and
a world of plants

21 USM Haller table
69"L/39"D/29"H
transparent glass

22 Shelving
149"W/21"D/26"H
with five drop-down doors
and five extension doors
with box inserts



23 Storage
60"W/15"D/43"H
with four drop-down doors



24 Storage
90"W/15"D/52"H
with seven drop-down doors
and two drawers



25 Coffee trolley
40"W/21"D/44"H
with pull handle, one extension
door with box insert, two drop
down doors, one divider shelf,
two USM Inos boxes and casters

Dining



26 Kitchen trolley
33"W/21"D/27"H
with a world of plants,
a pull handle and casters

27 Shelving
99"W/15"D/62"H
with twelve drop-down doors
and two glass doors



28 Sideboard
60"W/15"D/29"H
with two drop-down doors



29 Sideboard
90"W/15"D/25"H
with three drop-down doors



30 USM Haller table
69"W/30"D/29"H
Pastel gray laminate



31 Serving cart
33"W/21"D/26"H

Trends come and go while classic design is constant.

32 Media unit with integrated USM Haller E lighting*
136"W/15"D/57"H
with a world of plants, four extension doors and one drop-down door
*with a dimmable cold or warm white light



Entertainment



33 Sideboard
90"W/15"D/29"H
with three extension doors

34 Sideboard
50"W/15"D/29"H
with two drop-down doors
and a world of plants



35 Credenza
60"W/15"D/22"H
with four drop-down doors



36 Credenza 
60"W/15"D/29"H
with two drop-down doors



37 Sideboard
60"W/15"D/17"H
with two divider shelves,
cable cut-out and casters



38 Sideboard
60"W/15"D/17"H
with two drawers,
counterweight and casters

39 Sideboard
80"W/21"D/29"H
with one drop-down door,
one extension shelf,
three extension doors
and cable cut-out



Entertainment



40 Media Unit 
60"W/15"D/29"H
with two drop-down doors

41 Media Unit
120"W/21"D/17"H
with four drop-down doors
and casters



42 Media Unit 
60"W/15"D/23"H
with two drop-down doors



43 Media Unit 
60"W/21"D/17"H
with two drop-down doors,
cable cut-out and casters



44 Media Unit
90"W/21"D/16"H
with two drop-down doors,
one flip-up door
and one divider shelf



45 Media Unit 
30"W/15"D/23"H
with one drop-down door
and cable cut-out



46 Storage
75"W/15"D/16"H
with three drop-down doors



Would you like this piece of furniture to be wider, higher or lower? Configure your own furniture online.
www.usm.com

Enjoy the peace and relax.

A bedroom is a place to relax, to recharge – your sanctuary. With its sheer simplicity, USM design helps you to ease your mind – offering enough variations to create your own personal sense of calm.



Bedroom



↙
47 Storage
30"W/21"D/50"H
with one extension door,
two drop-down doors and
two A6 drawers

↙
48 Storage
90"W/15"D/39"H
with nine drawers



49 Storage
90"W/21"D/22"H
with three extension doors
and six 6" drawers



50 Storage
60"W/21"D/36"H
with four 6" drawers
and six extension doors



51 Storage
30"W/15"D/36"H
with three drawers

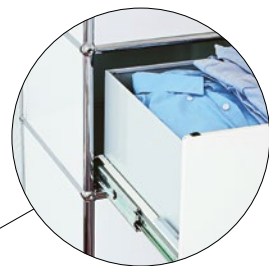

Spacious drawers
Discover the full
range of smart
organizational
accessories — p. 71.





↙
52 Nightstand 
20"W/15"D/23"H
with one drop-down door

→
53 Side table with integrated
USM Haller E lighting*
20"W/15"D/23"H
with one drop-down door
*with a dimmable cold or
warm white light

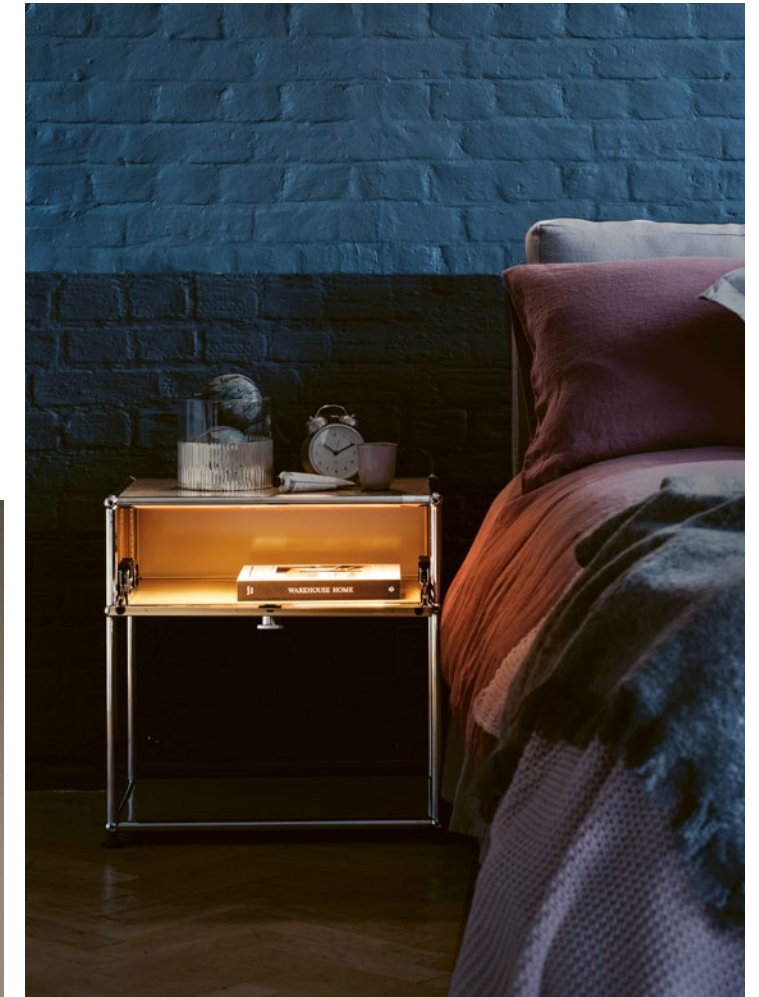

USB chargers transform the furniture
into a charging station for your mobile devices.



54 Storage
30"W/15"D/33"H
with two drop-down doors



55 Storage
40"W/15"D/23"H
with two drop-down doors



56 Storage 
30"W/15"D/29"H
with one drop-down door



57 Nightstand 
20"W/15"D/23"H
with one drop-down door

A playful start
to grow into
a great future.



↙
58 Storage
129"W/15"D/84"H
with ten drop-down doors

→
59 Storage box
15"W/15"D/16"H

↘
60 Storage box
23"W/15"D/17"H
cart with casters



61 Desk with storage box
53"W/21"D/23"H
with casters



62 Storage 
60"W/15"D/43"H
with four drop-down doors



63 Lowboard
80"W/15"D/16"H
with four drop-down doors

Kids

- ↙ 64 Shelving
90"W/28"D/29"H
with one drop-down door
- 65 Sideboard
30"W/15"D/29"H
with one drop-down door



Shelving

Beauty and function from all sides.

Whether it's your library or a collection of anything you hold dear, make it accessible from both sides. USM Haller remains discreet, focusing all the attention on what you place on it – minimalist design at its very best.

66 Shelving
117"W/15"D/77"H
with four drop-down doors,
two flip-up doors,
four extension doors with
one box insert low and
cable cut-out



Shelving



↙
67 Room divider
90"W/15"D/76"H
with six drop-down doors

→
68 Shelving
56"W/15"D/115"H
with four drop-down doors



Shelving



69 Shelving
90"W/15"D/57"H
with three drop-down doors
and three extension doors

70 Shelving
129"W/15"D/77"H
with three drop-down doors
and one flip-up door



With our configurator you
can playfully create your own
individual furniture.
www.usm.com



71 Shelving
120"W/15"D/85"H
with one drop-down door



72 Shelving
140"W/15"D/71"H
with ten drop-down doors



73 Shelving
150"W/15"D/85"H

Shelving



↙ 74 Glass showcase with integrated USM Haller E lighting*
150"W/15"D/36"H with ten glass doors
*with a dimmable cold or warm white light

↓ 75 Shelving with integrated USM Haller E lighting*
This piece is a custom configuration, please contact a USM sales design specialist.
*with a dimmable cold or warm white light

↓ 76 Side table
23"W/17"D/19"H with casters



Shelving

↙
77 Shelving
56"W/15"D/42"H
with two drop-down doors
and two extension doors
with box inserts

→
78 Shelving
99"W/15"D/90"H
with eleven drop-down doors
and four glass doors



Storage

Our versatility with an unpretentious facade.

Thanks to its modularity and timelessness, USM fits into every environment, fulfilling a wide range of functions within your home. It adapts to your needs and taste. And it helps you organize your home, offering all the space you need – wherever you want it.



↙
79 Mobile pedestal
30"W/21"D/30"H
with one drop-down door,
two extension doors,
one box insert and casters

→
80 Shelving
20"W/15"D/63"H
with three drawers



81 Sideboard
60"W/15"D/35"H
with two extension doors
and counterweight



82 Storage 
30"W/15"D/43"H
with three drop-down doors



83 Mobile storage
22"W/15"D/24"H
with three drawers,
box insert, counterweight
and casters



Organizing trays
Discover the full
range of smart
accessories —
p. 71.

Storage



84 Shelving
90"W/15"D/71"H
with four drop-down doors
and two extension doors

85 Shelving
218"W/23"D/104"H
with two drop-down doors,
twelve flip-up doors
and twenty extension doors
with ten box inserts



86 Sideboard
60"W/29"D/36"H
with six drop-down doors
and six extension doors

87 Glass showcase
41"W/15"D/53"H
with two drop-down doors
and two glass doors

Storage



↙
88 Wardrobe
113"W/50"D/86"H
with six drop-down doors,
four extension doors with
box inserts and a clothes rail

→
89 Wardrobe with integrated
USM Haller E lighting*
64"W/15"D/57"H
with two drop-down doors,
a clothes rail and plant panels
with a world of plants
*with a dimmable cold or
warm white light



90 Wardrobe
60"W/21"D/86"H
with seven drawers
and a clothes rail



91 Wardrobe
30"W/15"D/76"H
with two drawers and
a clothes rail



92 Wardrobe
109"W/59"D/71"H
with one drop-down door,
four extension shelves and
one drawer, two divider shelves
and three clothes rails

Storage

93 Shelving
Contact a design specialist
to customize your unique
solution.



Storage



↙
94 Shelving
40"W/15"D/32"H
with two drop-down doors

↓
95 Storage
60"W/15"D/57"H
with three drop-down doors



↘
96 USM Inos drawer set
Available in 15 standard
USM colors.

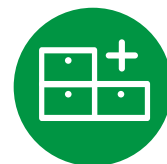

Design your individual
piece of USM online!
www.usm.com

Home office

Feel at home while you work at home.

The home office is a natural part of modern working life. An inspiring environment is not only stylish but enhances well-being and productivity. USM adds quality to the workplace in your home – and to your life at large.

97 Desk
103"W/21"D/43"H
with three drop-down doors
and one extension shelf



Home office



↙
 98 Shelving
 30"W/15"D/70"H
 with two drop-down doors,
 one divider shelf and one
 extension door with box insert

→
 99 Storage
 30"W/15"D/37"H
 with two drop-down doors,
 one drawer and cable cut-out



100 Shelving
 60"W/15"D/43"H
 with four extension doors
 and filing



101 Mobile storage
 40"W/15"D/24"H
 with four drop-down doors



102 Shelving
 141"W/15"D/71"H
 with thirteen drop-down doors

103 USM Haller desk
 59"W/30"D/29"H
 Pearl gray laminate

104 Shelving with integrated
USM Haller E lighting*
150"W/15"D/82"H
with a world of plants,
four drop-down doors and
two extension doors

*with a dimmable cold or
warm white light

105 USM Haller desk
rectangular
79"L/30"D/29"H
Black linoleum



Home office



- ↙
- 106 Sideboard
60"W/15"D/29"H
with four drop-down doors and
two USM Inos C4 box sets
-
- 107 Desk
46"W/21"D/29"H
with one drop-down door



108 Shelving 
30"W/15"D/71"H
with two drop-down doors



109 Credenza 
60"W/15"D/29"H
with two drop-down doors
and two extension doors
with filing



110 Shelving
30"W/15"D/57"H
with two drop-down doors



111 Desk
50"W/21"D/29"H
with two drop-down doors

- 112 Shelving
80"W/15"D/57"-94"H
with 3 drop-down doors,
two glass doors and
a world of plants
- 113 USM Kitos M,
height adjustable
69"L/30"D/28"-47"H
Linoleum Pebble
- 114 Mobile pedestal
17"W/21"D/24"H
with three drawers,
with counterweight and
casters



re think

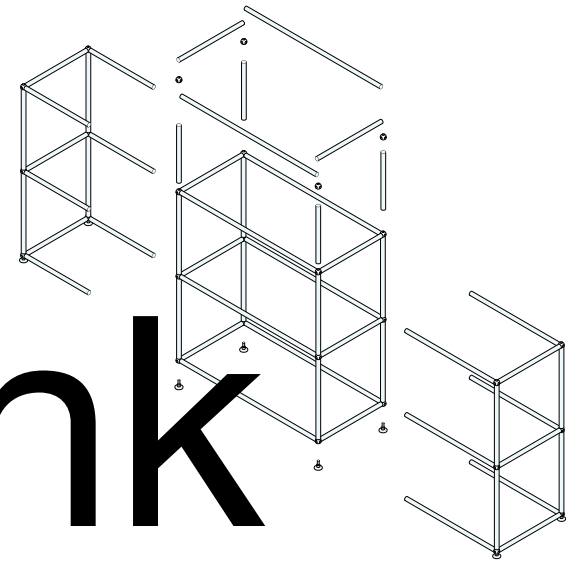

Rethink, redesign, revalue sums up the sustainable benefit of our products.

What and how much do you really need? What purposes should a piece of furniture serve? Experienced consultants and virtual planning tools enable us to support you to create a bespoke and conscious purchase. So that you get exactly what you really need, tailored to your current requirements. But don't worry, once furniture has been designed, it can always be rethought and adapted to new circumstances.

Each piece is unique, planned and assembled especially for you. Our furniture is designed to be forever reconfigured. Thanks to the high-quality finish and clever design, all components can be change and extended at any time without any problems. This leads to limitless creative freedom, more individuality in design and almost infinite cycles of use.

re design

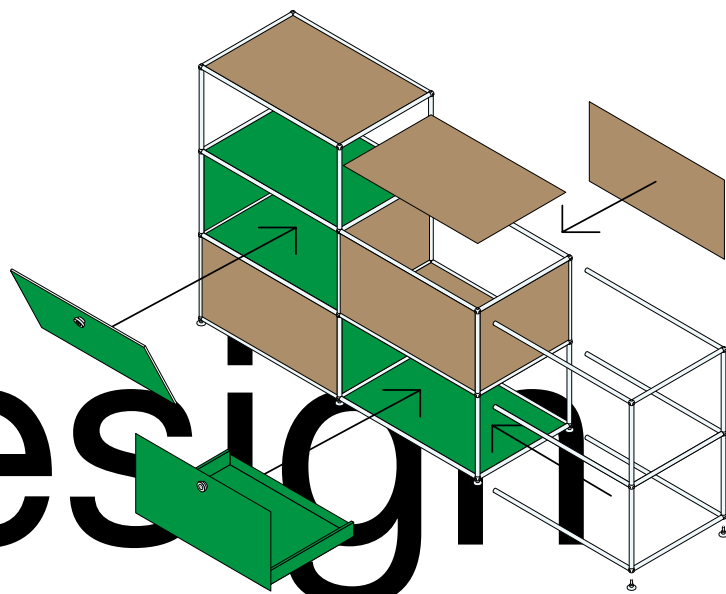

Our vision – becoming a fully circular business
We want to extend circularity principles beyond our products. That means adopting this philosophy throughout our company – from our product development to our manufacturing, and new business models, from our communications to our supply chain, operations and the expertise of our people.

re value

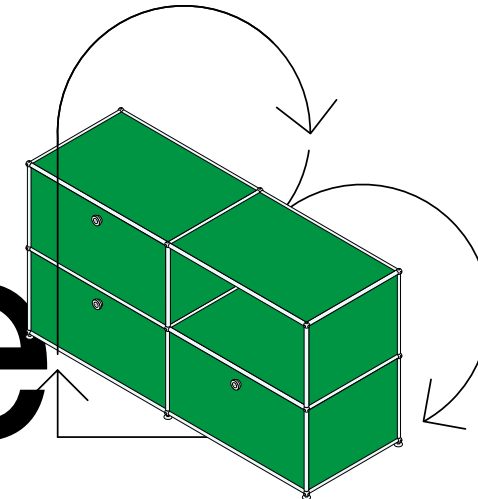

Thanks to the high quality, colours that never fade and a 100% modular system, decades-old USM furniture can be seamlessly combined and upgraded with new components. We believe a product that adapts to your style, your life, your changing needs is relevant and loved.

USM furniture is a valuable companion for life, across generations.



Our product lines USM Haller and USM Kitos M, accounting for more than 92% of our revenue, carry the Cradle-to-Cradle® certification. It is the leading multi-attribute standard used globally across industries for designing and making products that enable a healthy, fair and sustainable future according to the world's most advanced science-based measures.



All our four main product lines carry the UL Greenguard Certification for low chemical emission. Having undergone rigorous scientific testing to meet stringent emissions requirements, this certification approves that our products contribute to a healthier indoor air quality.

With the Science Based Targets initiative (SBTi), carried by several renowned organisations including the United Nations Global Compact and the World Wide Fund of Nature (WWF), we have committed to set near-time company-wide emission reductions in line with the latest climate science.

Learn more at www.usm.com/sustainability



USM Haller

The USM Haller system provides a wide variety of elements in standard sizes. Widths, depths and heights are indicated below. All measurements refer to the distance between axes.

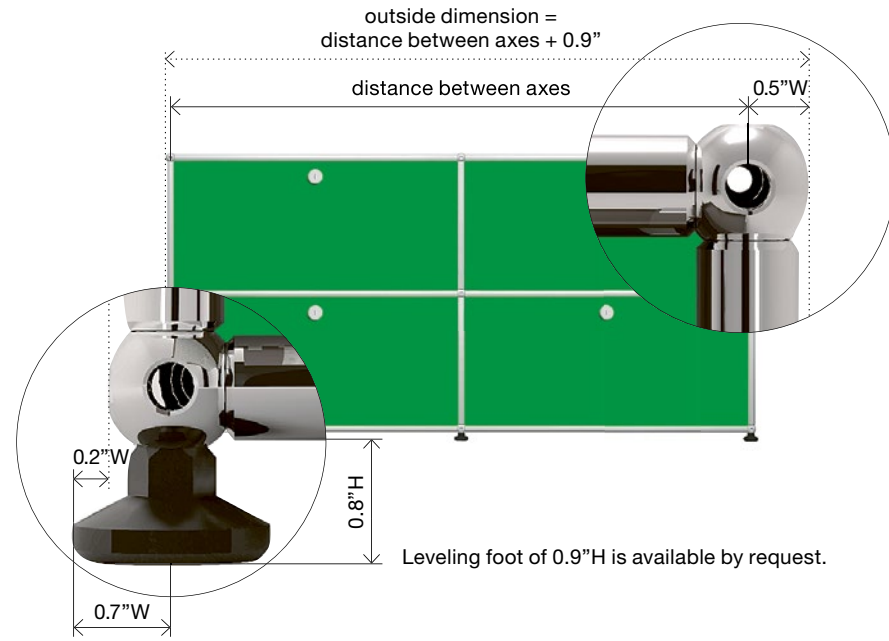

Your safety matters to us. Check out the USM safety instructions now. www.usm.com/safety

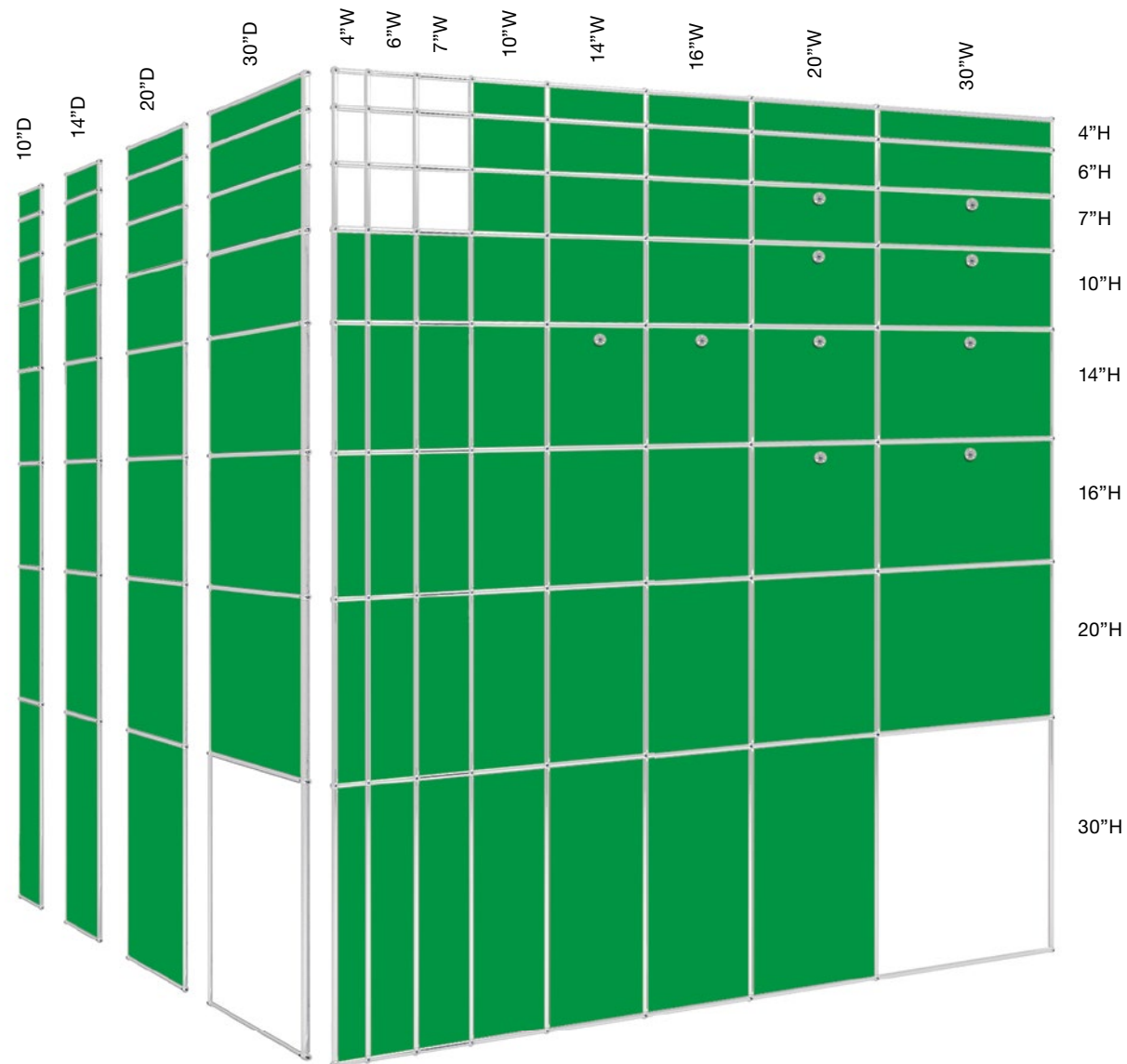

Panels

- 1 Metal panel
- 2 Glass panel
- 3 Acoustic panel
- 4 Perforated metal panel

Doors

- 5 Metal flip-up door*
- 6 Glass door
- 7 Acoustic drop-down door
- 8 Metal drop-down door
- 9 Metal extension door*

Shelves and drawers

- 10 Metal divider shelf
- 11 Glass divider shelf
- 12 Metal extension shelf
- 13 Metal angled shelf
- 14 Extension filing set with extension shelf
- 15 Drawer 4"
- 16 Drawer 6"
- 17 Drawer 10"
- 18 Drawer 12"
- 19 Metal plant panel with circular recesses to hold the pots

Accessories

- 20 Hanging file baskets
- 21 Metal box insert
- 21a Slide profile for metal box insert
- 22 Cable cut-out
- 23 Metal magnetic bookend
- 24 USM Inos Felt Box
- 25 USM Inos DVD tray
- 26 USM Inos CD tray
- 27 USM Inos angled file trays
- 28 Bookend
- 29 USM Inos box set, open
- 30 USM Inos box set, closed
- 31 USM Inos organizing drawer set



*Acoustic version available.

Illustration: USM Haller in 20"D.

USM Haller E

A modular structure of your design, either completely or partially equipped with e-Balls and e-Tubes, is connected to a source of electricity. The structure itself conducts the low voltage electricity to the desired location using the e-Balls, e-Connectors and e-Tubes to form a circuit. USB chargers or light sources can be snapped into place in pre-cut recesses. The power supply is drawn from any point near the ground. The power supply cable is attached to an e-Ball, and the power adapter is subsequently tucked underneath the furniture until only the operating switch remains visible. From this point the power supply requires no further cables but rather is integrated into the structure of the furniture.

Application options

- 1 **Glass panel**
Glass elements can be illuminated throughout.
- 2 **Without metal paneling**
Compartments without metal paneling can be completely illuminated.
- 3 **With metal paneling**
Compartments with metal paneling can be illuminated from the front.
- 4 **Compartment with an extension shelf**
The entire compartment with an extension shelf can be illuminated.
- 5 **Drop-down and extension door**
Via the "Light When Compartment Is Open" function, the light automatically turns on when the door is opened.
- 6 **Angled shelf**
The presentation space is illuminated from the front.
- 7 **Floor lighting**
With floor lighting, the light shines at a 25-degree angle under the furniture.
- 8 **Ambient lighting**
The light is directed vertically towards the back, illuminating the surroundings with a warm glow.
- 9 **e-USB charger**
It can be integrated in the same places as the e-Lights.

e-Elements

- 1 **e-Lights**
Dimmable, available in
– Warm white 2700 Kelvin
– Cold white 5700 Kelvin
Both with or without the "light at compartment opening" function.
- 2 **e-USB charger**
Provides a voltage of 5 volts to the connected device. (Capacity: 6.5 W)
- 3 **e-Dummy**
Sleek, black e-Dummy element, closes recesses that are unutilised. Can be changed for additional e-Lights or e-USB charger later.
- 4 **e-Tube (power outlet)**
Tubes with recesses for e-Lights, e-USB chargers or e-Dummy elements that can be easily snapped into place or replaced.

14"D, 1 recess
20"D, 2 recesses
30"D, 3 recesses
- 5 **e-Tube (conductive)**
The conductive e-Tube serves to conduct the electricity if no inserts are desired in this location. It is available in lengths of 30", 20", 16", 14", 10" and 7".
- 6 **e-Ball, e-Connector**
To enable the flow of electricity, the ball and connector were refined. The exterior dimensions remain unchanged. The distinguishing feature of the ball is the black insulation ring.
- 7 **e-Power supply**
Includes dimmer at the operating switch. Transforms the power supply voltage to 24 volts. (Capacity: 60 W)

CE

Engineered & Made in Switzerland.



Winner of the German Design Award 2019 for outstanding design quality in the Office Furniture category



Winner of the Wallpaper Design Awards 2018



Winner of the Focus Gold Award 2018 for outstanding design quality



Winner of the Muuz International Award 2018 in the furniture category



Winner of the FX Design Awards, Lighting Product 2017

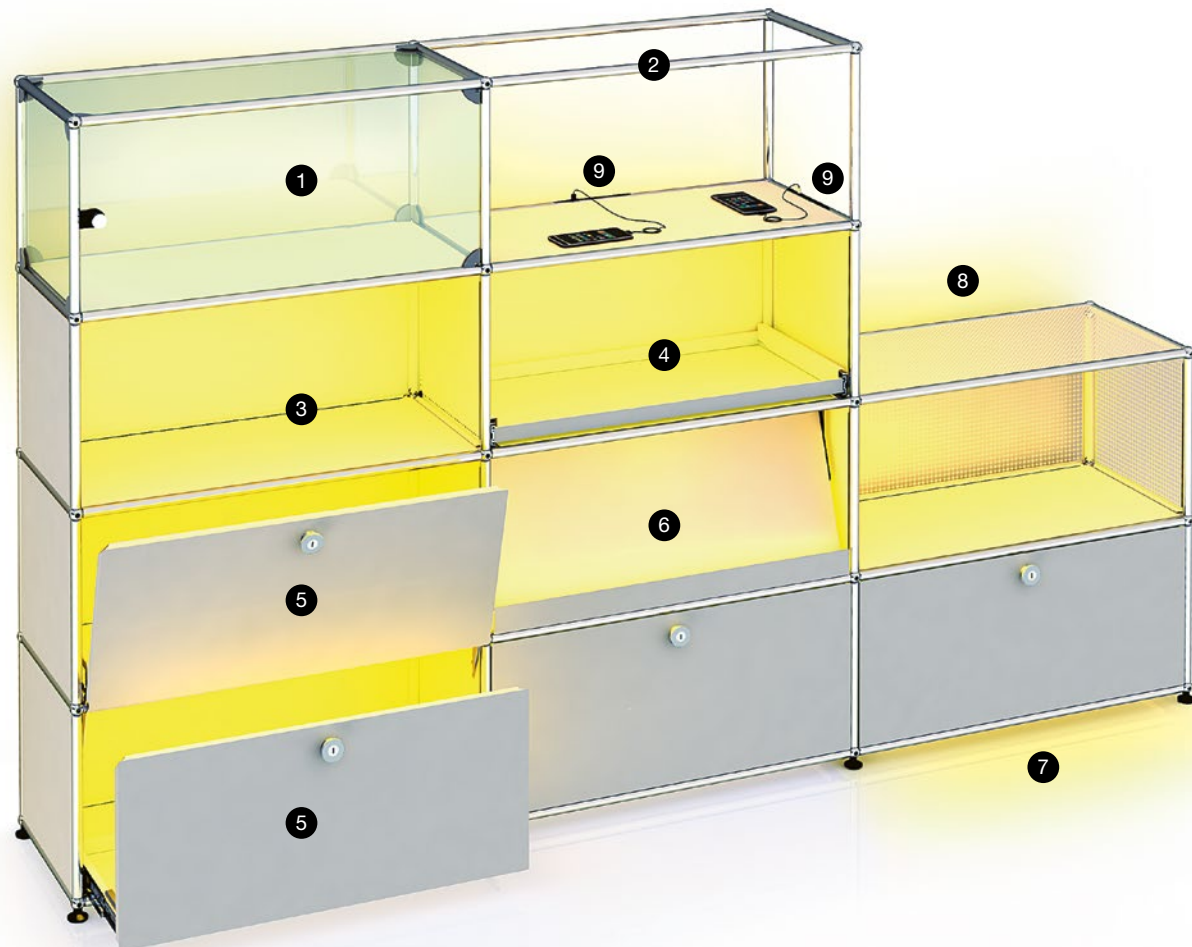

USM Haller table / desk

Designed almost 60 years ago, the USM Haller table still embodies timeless elegance. Its clean lines perfectly harmonize with the modular furniture system of the same name.

Classic table

Optional cable basket underneath the tabletop



USM Haller

29"H
120"W/39"D
120"W/30"D
98"W/39"D
98"W/30"D
89"W/39"D
89"W/30"D
39"W/39"D
30"W/30"D
59"W/20"D**
49"W/20"D**

29"H or
27"-34"H*
79"W/39"D
79"W/30"D
69"W/39"D
69"W/30"D
59"W/39"D
59"W/30"D
49"W/30"D

Sliding tabletop + adaptation points

Integrated cable tray accessible from above by sliding back the tabletop
Adaptation points for accessories



USM Haller Advanced

29"H or
27"-34"H*
79"W/39"D
79"W/30"D
69"W/39"D
69"W/30"D
59"W/39"D
59"W/30"D
49"W/30"D

Working desk

Optional cable basket underneath the tabletop
Removable adaptation points for accessories



USM Haller Plus

29"H
120"W/39"D
120"W/30"D

29"H or
27"-34"H*
79"W/39"D
79"W/30"D
69"W/39"D
69"W/30"D
59"W/39"D
59"W/30"D
49"W/30"D

Occasional / coffee table



USM Haller occasional / coffee table

15"H
120"W/39"D
120"W/30"D
98"W/39"D
98"W/30"D
89"W/39"D
89"W/30"D
79"W/39"D
79"W/30"D
69"W/39"D
69"W/30"D
59"W/39"D
49"W/30"D
39"W/39"D
30"W/30"D

* Manual height adjustment with a removable handle.

** Note: These sizes are not yet included in the standard range.

Accessories for all USM Haller table / desk

- 1 **Grommet hatch for network access**
Flush hinged cover set into the tabletop for easy network access, can be positioned right or left.
- 2 **Cable management**
For the Advanced table type, a cable tray integrated under the tabletop offers storage room and attachment options for all cables and technical components. For the traditional USM Haller Table and the USM Haller Plus, a cable basket can be attached.
- 3 **CPU holder**
Computers in various sizes can be mounted using a simple holding device under the table.
- 4 **Link chain**
Holds and directs cables to the power source. Flexible and adjustable to various lengths.
- 5 **Flat screen pivot arm**
Screens are screwed to the height adjustable pivot arm using a mounting plate (VESA standard). Available for USM Haller classic desk: The pivot arm can be mounted onto the table edges with the universal holder or into the table leg using an assembly tube. Available for USM Haller Plus and Advanced: The bracket can be connected directly to one of the adaptation points.
- 5a **Options Mounting at different heights**
is possible for screens weighing up to 26 pounds.
- 5b **Continuous height adjustment**
for screens weighing up to 26 pounds.
- 6 **Front and side panel**
A black mesh fabric can be attached to the back or the side under the table frame. Available for the following table sizes: 79"W, 69"W, 59"W, 49"W, 39"W, 30"W and depths: 39"D, 30"D.
- 7 **Material tray**
Provides room for writing instruments and can be discreetly stowed under the tabletop.
- 8 **USM Privacy Panels**
Fitted on the long side of the table to provide individualisation and privacy. 14"H or 28"H. Available for the following table sizes: 120"W, 98"W, 89"W, 79"W, 69"W, 59"W, 49"W*

Cable duct
The classic USM Haller table can be updated with a black aluminum cable duct section, with lids that fold open on both sides, to integrate cables. This enables the table depths to be expanded to the EU standard of more than 32". Available for the following table sizes: of 79"W, 69"W, 59"W, 49"W, 39"W, 35"W, 30"W.

Accessories for USM Haller Plus / Advanced desk

- 9 **Flat screen support bar**
The bracket is inserted into the adaptation points. Up to two screens (max. 2 x 26 pounds) can be attached using a mounting plate (VESA standard). Screens can be mounted at different heights; screens can be adjusted with ball joints.
- 9a **Options Flat screen support bar fix**
- 9b **Options Flat screen support bar adjustable**
Move forwards or backwards two notches at a time to adjust the viewing distance.
- 10 **USB adapter**
The adapter can be used for USB A 3.0 and C connections. It can easily be inserted into the adaptation point. Usable as power supply or for data transfer.
- 11 **Lamp peg**
An optional lamp peg for easy attachment of traditional table lamps. Electrification is possible through the adaptation point.

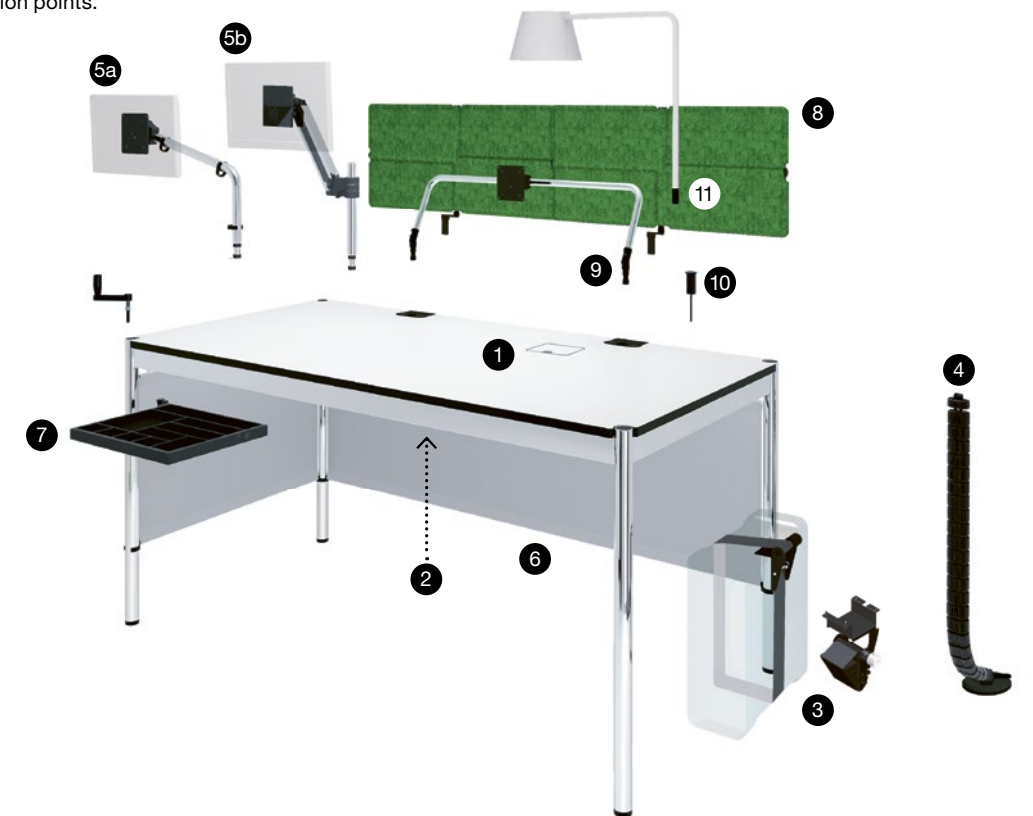

USM Kitos M and E table / desk

Each desk of the USM Kitos M and E family offers integrated smart solutions for electrification, excluding free-standing.

Why USM Kitos M?

The "M" in its name stands for mechanical spring-loaded height adjustment; adjustment time approx. 1 sec. with zero energy consumption. This system is more than 10 times faster than the electronic equivalent and has an extremely long operating life.

Why USM Kitos E?

Maximum functionality and captivating design – USM Kitos E unites all requirements in one modern workplace: continuous height adjustability and maximum stability. A distinction is made between fixed and motor-driven legs in the E1, E2 and E3 models.

E1



29"H
With or without middle traverse

E2 with 1 motor



28"–47"H
Adjustment time approx. 30 sec.
With middle traverse

E3 with 2 motors



26"–51"H
Adjustment time approx. 20 sec.
With middle traverse

Basic desk

Integrated cable tray underneath the tabletop



USM Kitos M

28"–47"H
70"W/35"D
69"W/30"D
63"W/32"D

Sliding tabletop

Integrated cable tray accessible from above by sliding back the tabletop
Adaptation points for accessories



USM Kitos M Plus

28"–47"H
70"W/35"D
69"W/30"D
63"W/32"D

Extra size

Integrated cable tray underneath the tabletop and accessible from all sides



USM Kitos M Meeting

28"–45"H
99"W/40"D
89"W/40"D

Side table



USM Kitos E Free-standing

29"H or 28"–43"H
Square
30"W/30"D or 35"W/35"D
Round
Ø: 35" or 43"

USM Kitos E

70"W/35"D**
69"W/30"D
63"W/32"D**
Available with E1*, E2 or E3** columns

USM Kitos E Plus

70"W/35"D
69"W/30"D
63"W/32"D
Available with E1*, E2 or E3 columns

USM Kitos E Meeting

99"W/50"D
99"W/40"D
89"W/40"D
Available with E1, E2 or E3 columns

The table can also be provided with an asymmetrical version of the middle traverse, for extra legroom. (This is not possible with the USM Kitos E / M Meeting.)

* Available with or without middle traverse.

** Available in a GS-Mark tested version with 0.12" table edge radius and the asymmetrical middle traverse.

Accessories for all USM Kitos M and E table / desk

- Grommet hatch for network access**
Flush hinged cover set into the tabletop for easy network access, can be positioned at two different locations.
- CPU holder**
Computers in various sizes can either be mounted using a simple holding device under the height-adjustable tabletop or attached to the table column.
- Link chain**
Holds and directs cables to the power source. Flexible and adjustable to various lengths.
- USM Privacy Panels**
Fitted on the long side of the table to provide individualisation and privacy. 14"H or 28"H. Available for the following table sizes: 99"W, 89"W, 70"W, 69"W, 63"W.

Accessories for all USM Kitos M and E table / desk, except USM Kitos M Meeting / E Meeting

- Flat screen pivot arm**
Screens are screwed to the height adjustable pivot arm using a mounting plate (VESA standard). Available for USM Kitos E/M desk: The pivot arm can be mounted onto the table edges with the universal holder. Available for USM Kitos M and E Plus: The bracket can be connected directly to one of the adaptation points.
- Options**
 - Mounting at different heights**
is possible for screens weighing up to 26 pounds.
 - Continuous height adjustment**
for screens weighing up to 26 pounds.
- Front panel**
A black mesh fabric attaches to the front under the tabletop. Available for the following table sizes: 70"W, 69"W, 63"W.
- Material tray**
Provides room for writing instruments and can be discreetly stowed under the tabletop.

Accessories for USM Kitos M Plus / E Plus

- Flat screen support bar**
The bracket is inserted into the adaptation points. Up to two screens (max. 2 x 26 pounds) can be attached using a mounting plate (VESA standard). Screens can be mounted at different heights; screens can be adjusted with ball joints.
 - Flat screen support bar fix**
 - Flat screen support bar adjustable**
Move forwards or backwards 2 notches at a time to adjust the viewing distance.
- USB adapter**
The adapter can be used for USB A 3.0 and C connections. It can easily be inserted into the adaptation point. Usable as power supply or for data transfer.
- Lamp peg**
An optional lamp peg for easy attachment of traditional table lamps. Electrification is possible through the adaptation point.

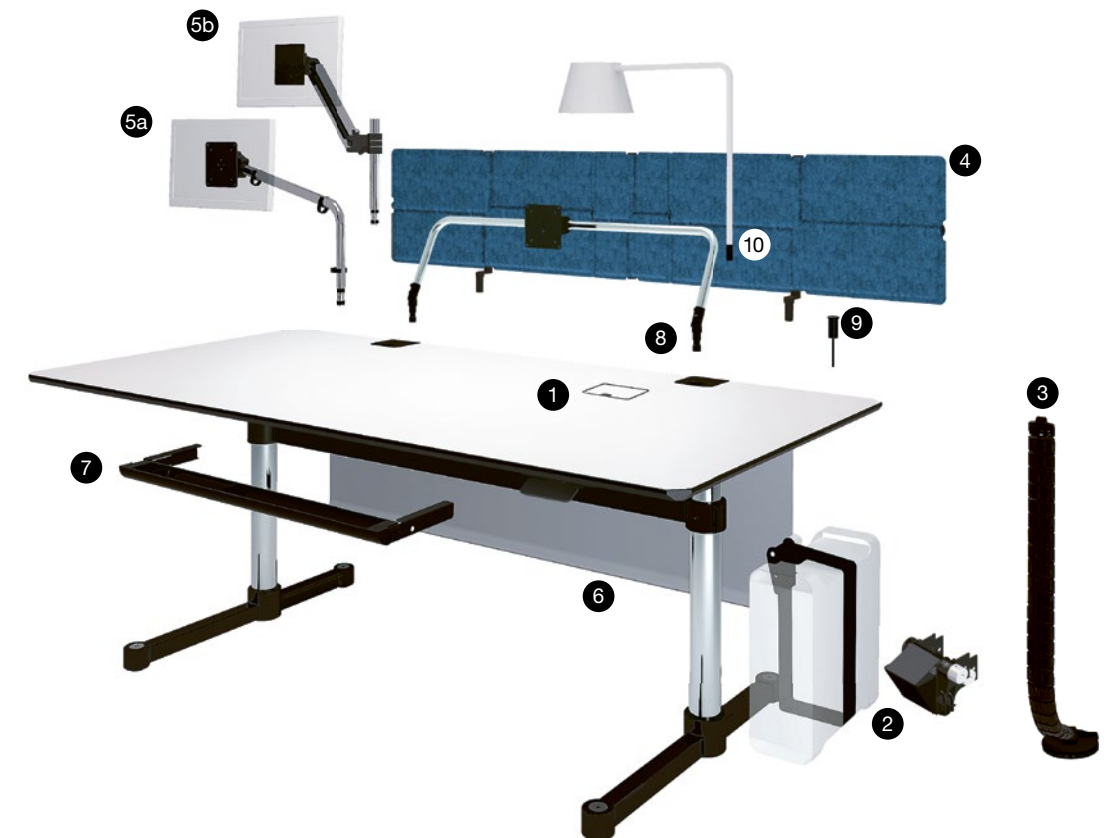

Accessories



1



2

1 Metal, magnetic bookend
Available in pure white and graphite black.

2 Pivoting pen holder
Provides room for writing instruments and can be discreetly stowed under the tabletop.

3 USM Inos internal organization
Plastic inserts in metal trays are ideal for storing small bits and pieces, whether in the home office or in the house.

4 USM Inos C4 box set
Inos box set fits into any piece of USM furniture. Available in all 14 USM colors. Closed 5- or 10-drawer C4 box sets are available in graphite black and pure white.

5 USM Inos Felt Box
The new USM Inos Boxes organize, store and protect both your treasures and everyday paraphernalia of life. Several boxes can be stacked on top of each other with the help of trays, which can also be used as covers or serving trays, or to hold assorted small items around the home. These soft storage boxes made of nonwoven polyester are available in four different sizes and in light gray and anthracite.

6 World of plants for USM Haller
Lively evergreen landscapes can now be easily integrated into the structure of USM Haller.



6



3



4

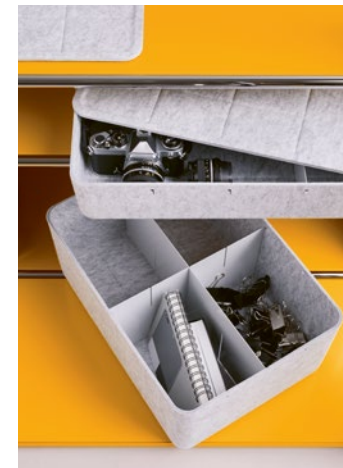

5

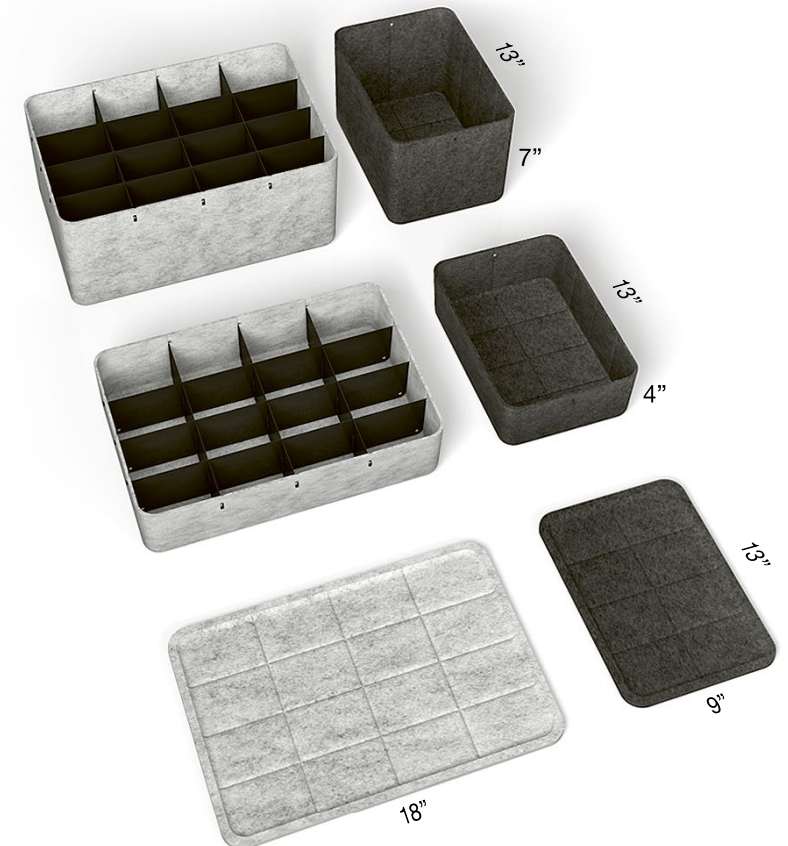

Colors & surfaces

USM Haller



Metal

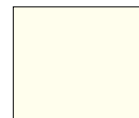

Pure white
RAL 9010



Light gray
RAL 7035



USM matte silver



USM mid-gray



Anthracite
RAL 7016

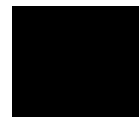

Graphite black
RAL 9011



Steel blue
RAL 5011



Gentian blue
RAL 5010



USM green



Golden yellow
RAL 1004



Pure orange
RAL 2004



USM ruby red



USM brown



USM beige



Olive green
RAL 6003

USM Haller and USM Kitos tables / desks



Powder-coated MDF



Pure white
RAL 9010

Transparent glass



Transparent glass

Linoleum



Ash linoleum



Charcoal linoleum



Black linoleum

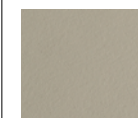

Pebble linoleum



Mauve linoleum

Laminate



Pearl gray laminate



Pastel gray laminate



Light mid-gray laminate



Dark warm gray laminate

Fenix



Fenix,
Bianco Kos



Fenix,
Grigio Londra



Fenix,
Nero Ingo

Oiled or lacquered veneer

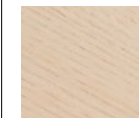

White oiled oak veneer

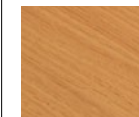

Natural oiled oak veneer

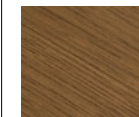

Brown oiled oak veneer



Natural lacquered oak veneer



Natural lacquered beech veneer

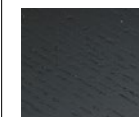

Black lacquered oak veneer

The tabletops in glass are only available for USM Haller desks up to 79"W and all USM Kitos desks with a fixed height (29"W) or stepwise height adjustment and continuous height adjustment (27"-31"H / 42"H).

Other colors and surfaces available upon request.

Prices and delivery times of table surfaces upon request.

USM Privacy Panels



Fabric panel

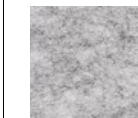

Light gray

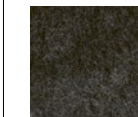

Anthracite



Blue



Green

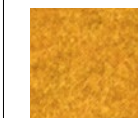

Yellow

USM Inos box



Fabric panel



Light gray

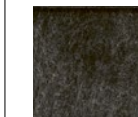

Anthracite

USM Inos drawer set



Metal

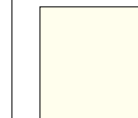

Pure white
RAL 9010



USM matte silver



Anthracite
RAL 7016



Steel blue
RAL 5011



USM green



Pure orange
RAL 2004



USM brown



Olive green
RAL 6003

The following options are available in graphite black and pure white only: USM Inos drawer set, 5 drawers, open USM Inos drawer set, 10 drawers, closed USM Inos drawer set, 10 drawers, open

Planters



Clay

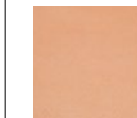

Terracotta

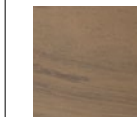

Basalt

Details

USM Haller



Metal

USM Haller table

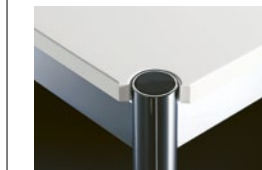

Powder-coated MDF

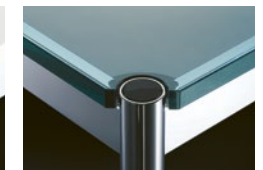

Transparent glass

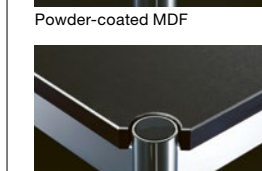

Linoleum

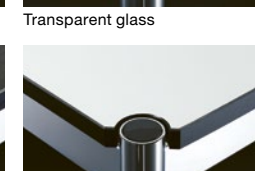

Laminate

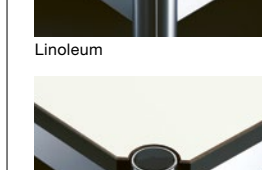

Fenix

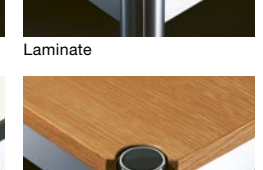

Oiled or lacquered veneer

USM Kitos table



Powder-coated MDF

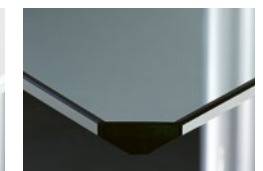

Transparent glass



Linoleum

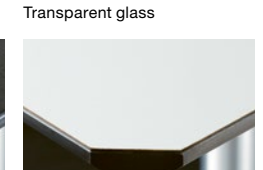

Laminate

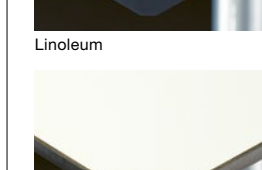

Fenix

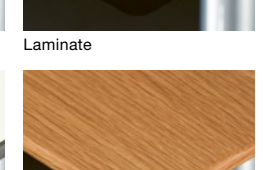

Oiled or lacquered veneer



06.2024, us, 1500



Switzerland

USM U. Schärer Söhne AG
Thunstrasse 55, 3110 Münsingen
Phone +41 31 720 72 72, info.ch@usm.com

Germany

USM U. Schärer Söhne GmbH
Siemensstraße 4a, 77815 Bühl
Phone +49 7223 80 94 0, info.de@usm.com

France

USM U. Schärer Fils SA, Showroom
23, rue de Bourgogne, 75007 Paris
Phone +33 1 53 59 30 37, info.fr@usm.com

United Kingdom

USM U. Schaerer Sons Ltd., London Showroom
Ground Floor, 49–51 Central St., London, EC1V 8AB
Phone +44 207 183 3470, info.uk@usm.com

USA

USM U. Schaerer Sons Inc., New York Showroom
28–30 Greene Street, New York, NY 10013
Phone +1 212 371 1230, info.us@usm.com

Japan

USM U. Schaerer Sons K.K., Tokyo Showroom
Marunouchi MY PLAZA 1 · 2F
2-1-1 Marunouchi, Chiyoda-ku, Tokyo 100-0005
Phone +81 3 6635 9420, info.jp@usm.com

All other countries
contact USM Switzerland.

www.usm.com



USM creative at home